



ON Semiconductor®

FDBL86210-F085

N-Channel Power Trench® MOSFET

150V, 169A, 6.3mΩ

Features

- Typ $r_{DS(on)}$ = 5mΩ at $V_{GS} = 10V$, $I_D = 80A$
- Typ $Q_{g(tot)}$ = 70nC at $V_{GS} = 10V$, $I_D = 80A$
- UIS Capability
- RoHS Compliant
- Qualified to AEC Q101

Applications

- Automotive Engine Control
- Powertrain Management
- Solenoid and Motor Drivers
- Integrated Starter/alternator
- Primary Switch for 12V Systems

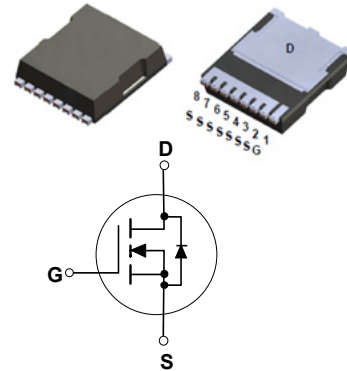

MOSFET Maximum Ratings $T_J = 25^\circ C$ unless otherwise noted

Symbol	Parameter	Ratings	Units
V_{DSS}	Drain to Source Voltage	150	V
V_{GS}	Gate to Source Voltage	±20	V
I_D	Drain Current - Continuous ($V_{GS}=10$) (Note 1)	$T_C = 25^\circ C$	A
	Pulsed Drain Current	$T_C = 25^\circ C$	
E_{AS}	Single Pulse Avalanche Energy (Note 2)	502	mJ
P_D	Power Dissipation	500	W
	Derate above 25°C	3.3	W/°C
T_J, T_{STG}	Operating and Storage Temperature	-55 to + 175	°C
$R_{\theta JC}$	Thermal Resistance Junction to Case	0.3	°C/W
$R_{\theta JA}$	Maximum Thermal Resistance Junction to Ambient (Note 3)	43	°C/W

Package Marking and Ordering Information

Device Marking	Device	Package	Reel Size	Tape Width	Quantity
FDBL86210	FDBL86210-F085	MO-299A	-	-	-

Notes:

- 1: Current is limited by junction temperature.
- 2: Starting $T_J = 25^\circ C$, $L = 0.24mH$, $I_{AS} = 64A$, $V_{DD} = 100V$ during inductor charging and $V_{DD} = 0V$ during time in avalanche
- 3: $R_{\theta JA}$ is the sum of the junction-to-case and case-to-ambient thermal resistance where the case thermal reference is defined as the solder mounting surface of the drain pins. $R_{\theta JC}$ is guaranteed by design while $R_{\theta JA}$ is determined by the user's board design. The maximum rating presented here is based on mounting on a 1 in² pad of 2oz copper.

FDBL86210-F085 N-Channel Power Trench® MOSFET

Typical Characteristics

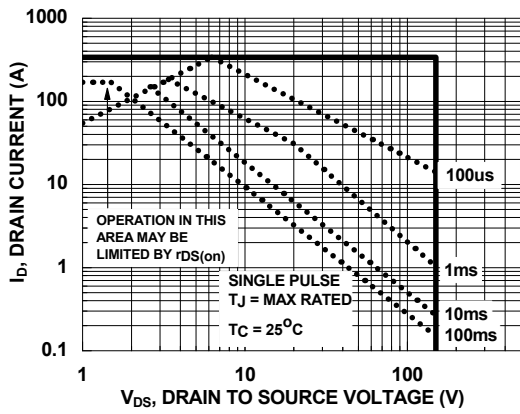
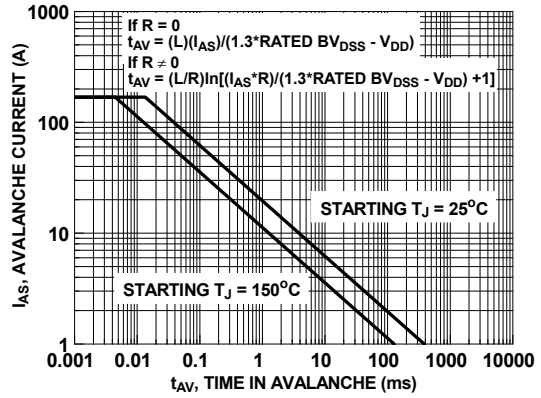

Figure 5. Forward Bias Safe Operating Area



NOTE: Refer to ON Semiconductor Application Notes AN7514 and AN7515

Figure 6. Unclamped Inductive Switching Capability

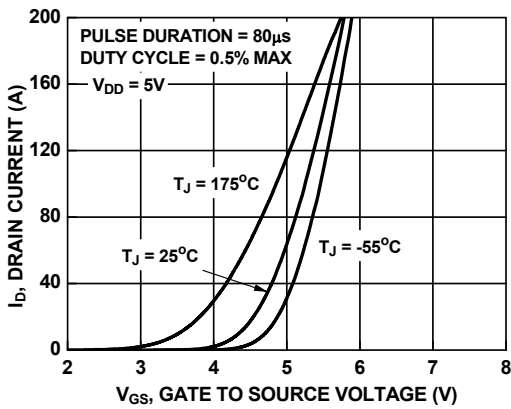

Figure 7. Transfer Characteristics

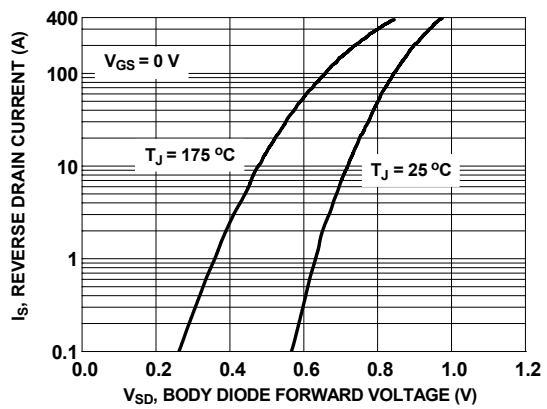

Figure 8. Forward Diode Characteristics

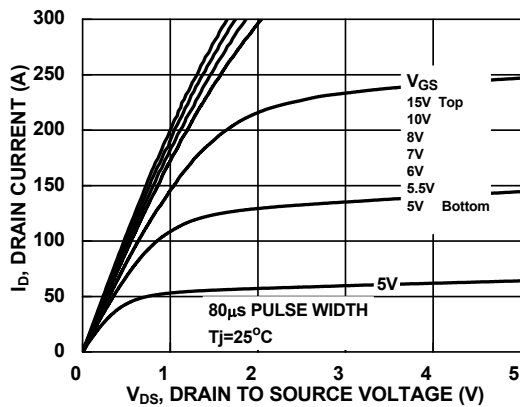

Figure 9. Saturation Characteristics

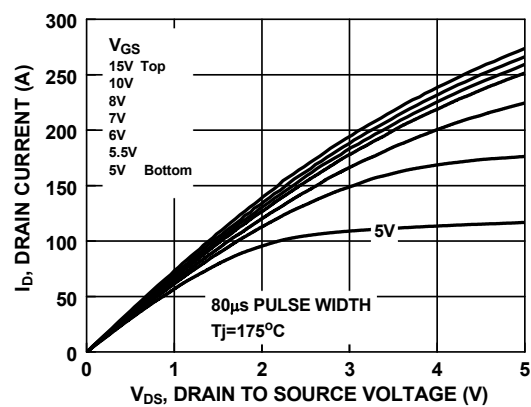

Figure 10. Saturation Characteristics

Typical Characteristics

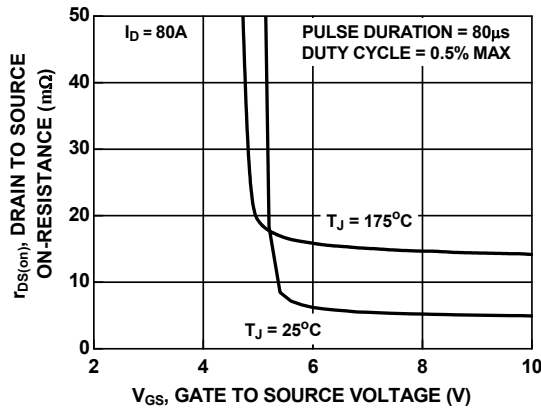

Figure 11. R_{dson} vs Gate Voltage

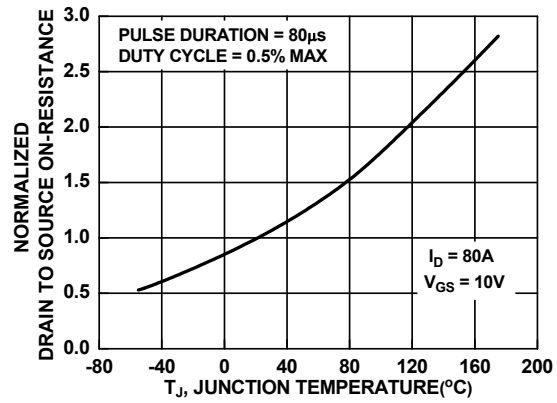

Figure 12. Normalized R_{dson} vs Junction Temperature

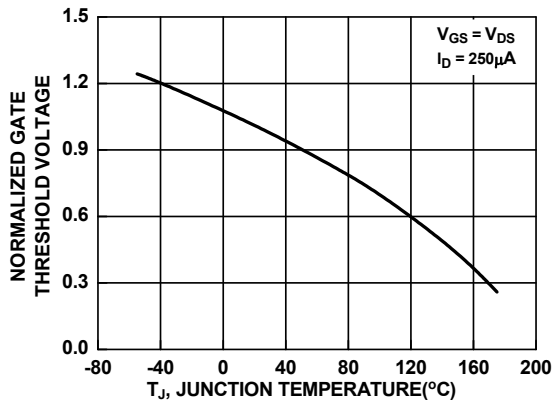

Figure 13. Normalized Gate Threshold Voltage vs Temperature

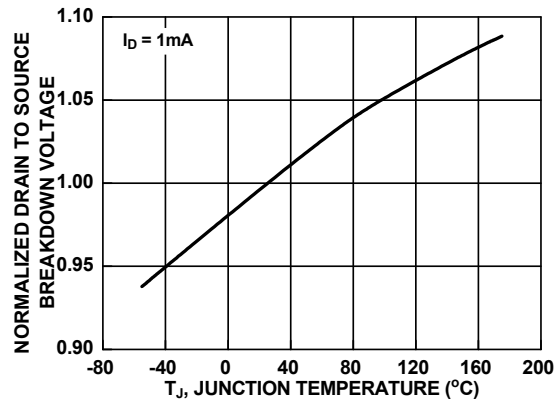

Figure 14. Normalized Drain to Source Breakdown Voltage vs Junction Temperature

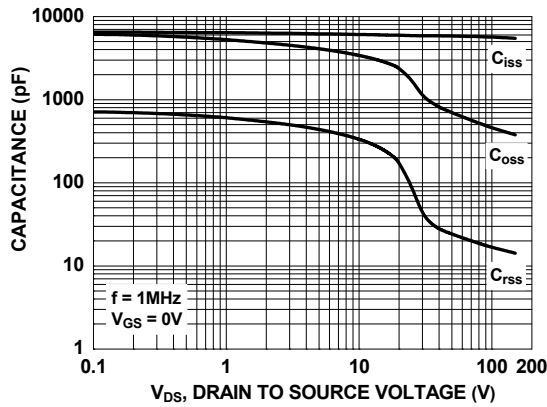

Figure 15. Capacitance vs Drain to Source Voltage

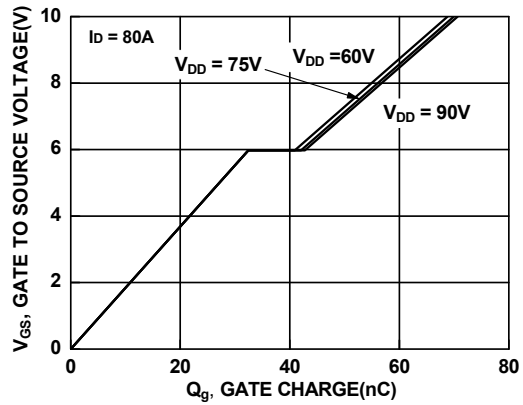

Figure 16. Gate Charge vs Gate to Source Voltage

