

Application Note

AN- EVAL-2QR0680Z-40W

40W20V Evaluation Board with Quasi-Resonant CoolSET[®] ICE2QR0680Z

Power Management & Supply



Published by
Infineon Technologies AG
81726 Munich, Germany
© 2016 Infineon Technologies AG
All Rights Reserved.

Legal Disclaimer

The information given in this document shall in no event be regarded as a guarantee of conditions or characteristics. With respect to any examples or hints given herein, any typical values stated herein and/or any information regarding the application of the device, Infineon Technologies hereby disclaims any and all warranties and liabilities of any kind, including without limitation, warranties of non-infringement of intellectual property rights of any third party.

Information

For further information on technology, delivery terms and conditions and prices, please contact the nearest Infineon Technologies Office (www.infineon.com).

Warnings

Due to technical requirements, components may contain dangerous substances. For information on the types in question, please contact the nearest Infineon Technologies Office.

Infineon Technologies components may be used in life-support devices or systems only with the express written approval of Infineon Technologies, if a failure of such components can reasonably be expected to cause the failure of that life-support device or system or to affect the safety or effectiveness of that device or system. Life support devices or systems are intended to be implanted in the human body or to support and/or maintain and sustain and/or protect human life. If they fail, it is reasonable to assume that the health of the user or other persons may be endangered.

AN- EVAL-2QR0680Z-40W

Revision History: 7 September 2016 **V1.1**

Previous Version: V1.0

Page	Subjects (major changes since last revision)
6, 7, 8, 9, 11, 12, 17	Typo errors

40W20V Evaluation Board with Quasi-Resonant CoolSET® ICE2QR0680Z
 License to Infineon Technologies Asia Pacific Pte Ltd

AN-PS0066

Eric Kok Siu Kam

Eric.kok@infineon.com

<p>We Listen to Your Comments Any information within this document that you feel is wrong, unclear or missing at all? Your feedback will help us to continuously improve the quality of this document. Please send your proposal (including a reference to this document) to: comments@infineon.com</p>	
---	---

Table of Contents

1	Content	6
2	Evaluation Board	6
3	List of Features	6
4	Technical Specifications	7
5	Circuit Description.....	7
5.1	Mains Input and Rectification	7
5.2	Integrated MOSFET and PWM Control.....	7
5.3	Output Stage.....	7
5.4	Feedback Loop.....	7
6	Circuit Operation	8
6.1	Startup Operation.....	8
6.2	Normal Mode Operation	8
6.3	Primary side peak current control.....	8
6.4	Digital Frequency Reduction	8
6.5	Burst Mode Operation	8
7	Protection Features	9
7.1	Vcc under voltage and over voltage protection.....	9
7.2	Foldback point protection	9
7.3	Open loop/over load protection.....	9
7.4	Adjustable output overvoltage protection.....	9
7.5	Short winding protection.....	9
7.6	Auto restart for over temperature protection	9
8	Circuit diagram	10
8.1	PCB Top side.....	11
8.2	PCB Bottom Layer	11
9	Component List	12
10	Transformer Construction	13
11	Test Results	14
11.1	Efficiency and standby performance	14
12	References	17

1 Content

This application note is a description of 40W switching mode power supply evaluation board designed in a quasi-resonant flyback converter topology using ICE2QR0680Z Quasi-resonant CoolSET[®]. The target application of ICE2QR0680Z are for set-top box, portable game controller, DVD player, netbook adapter and auxiliary power supply for LCD TV, etc. With the CoolMOS[®] integrated in this IC, it greatly simplifies the design and layout of the PCB. Due to valley switching, the turn on voltage is reduced and this offers higher conversion efficiency comparing to hard-switching flyback converter. With the DCM mode control, the reverse recovery problem of secondary rectify diode is relieved. And for its natural frequency jittering with line voltage, the EMI performance is better. Infineon's digital frequency reduction technology enables a quasi-resonant operation till very low load. As a result, the system efficiency, over the entire load range, is significantly improved compared to conventional free running quasi resonant converter implemented with only maximum switching frequency limitation at light load. In addition, numerous adjustable protection functions have been implemented in ICE2QR0680Z to protect the system and customize the IC for the chosen application. In case of failure modes, like open control-loop/over load, output overvoltage, and transformer short winding, the device switches into Auto Restart Mode or Latch-off Mode. By means of the cycle-by-cycle peak current limitation plus foldback point correction, the dimension of the transformer and current rating of the secondary diode can both be optimized. Thus, a cost effective solution can be easily achieved.

2 Evaluation Board

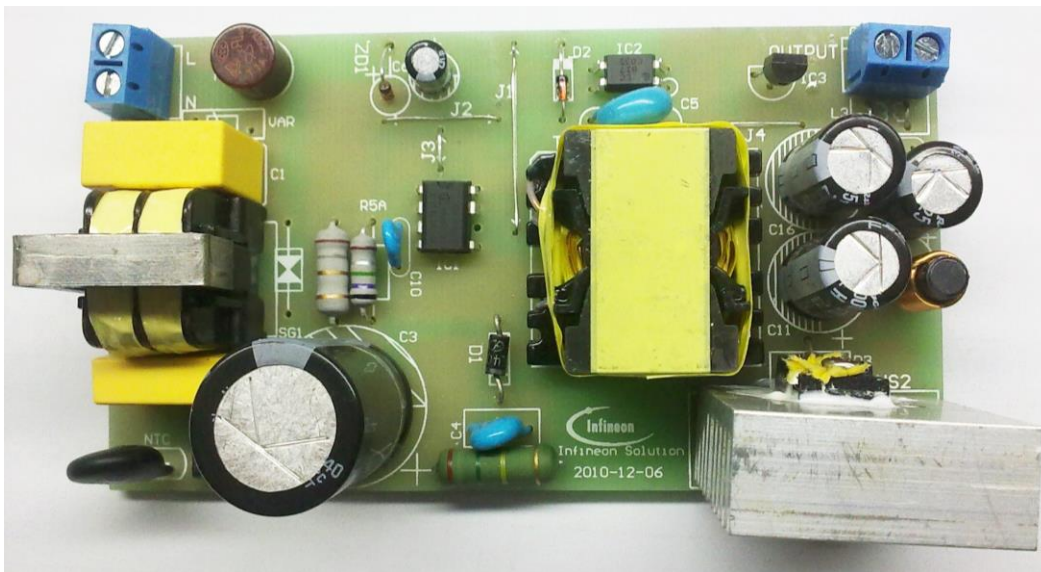

Figure 1 EVALQRC-ICE2QR0680Z

3 List of Features

➤ 800V avalanche rugged CoolMOS [®] with built in depletion startup cell
➤ Quasi-resonant operation
➤ Digital frequency reduction with decreasing load
➤ Cycle-by-cycle peak current limitation with foldback point correction
➤ Built-in digital soft-start
➤ Direct current sensing with internal Leading Edge Blanking Time
➤ VCC under voltage protection: IC stop operation, recover with soft start
➤ VCC over voltage protection: IC stop operation, recover with soft start
➤ Openloop/Overload protection: Auto Restart
➤ Output overvoltage protection: Latch-off with adjustable threshold
➤ Short-winding protection: Latch-off
➤ Over temperature protection: Auto Restart

4 Technical Specifications

Input voltage	85Vac~282Vac
Input frequency	50Hz, 60Hz
Output voltage and current	20V 2.0A
Output power	40W
Average Efficiency	>85% at full load
Standby power	<100mW@ no load
Minimum switching frequency at full load, minimum input voltage	65kHz

5 Circuit Description

5.1 Mains Input and Rectification

The AC line input side comprises the input fuse F1 as overcurrent protection. The X2 Capacitors C1 and Choke L1 form a main filter to minimize the feedback of RFI into the main supply. After the bridge rectifier BR1, together with a smoothing capacitor C2, provide a voltage of 70VDC to 380 VDC depending on mains input voltage.

5.2 Integrated MOSFET and PWM Control

ICE2QR0680Z is comprised of a power MOSFET and the quasi-resonant controller; this integrated solution greatly simplifies the circuit layout and reduces the cost of PCB manufacturing. The PWM switch-on is determined by the zero-crossing input signal and the value of the up/down counter. The PWM switch-off is determined by the feedback signal V_{FB} and the current sensing signal V_{CS} . ICE2QR0680Z also performs all necessary protection functions in flyback converters. Details about the information mentioned above are illustrated in the product datasheet.

5.3 Output Stage

On the secondary side, 20V output, the power is coupled out via a schottky diode D3. The capacitors C11 and C16 provide energy buffering followed by the L-C filters L3, C12 and C17 to reduce the output ripple and prevent interference between SMPS switching frequency and line frequency considerably. Storage capacitor C11 and C16 are designed to have an internal resistance (ESR) as small as possible. This is to minimize the output voltage ripple caused by the triangular current.

5.4 Feedback Loop

For feedback, the output is sensed by the voltage divider of R10, R11 and R12 and compared to TL431 internal reference voltage. C14, C15 and R8 comprise the compensation network. The output voltage of TL431 is converted to the current signal via opto-coupler IC2 and two resistors R6 and R7 for regulation control.

6 Circuit Operation

6.1 Startup Operation

Since there is a built-in startup cell in the ICE2QR0680Z, there is no need for external start up resistor, which can improve standby performance significantly.

When VCC reaches the turn on voltage threshold 18V, the IC begins with a soft start. The soft start implemented in ICE2QR0680Z is a digital time-based function. The preset soft start time is 12ms with 4 steps. If not limited by other functions, the peak voltage on CS pin will increase step by step from 0.32V to 1V finally. After IC turns on, the Vcc voltage is supplied by auxiliary windings of the transformer.

6.2 Normal Mode Operation

The secondary output voltage is built up after startup. The secondary regulation control is adopted with TL431 and opto-coupler. The compensation network C14, C15 and R8 constitute the external circuitry of the error amplifier of TL431. This circuitry allows the feedback to be precisely controlled with respect to dynamically varying load conditions, therefore providing stable control.

6.3 Primary side peak current control

The MOSFET drain source current is sensed via external resistor R5 and R5A. Since ICE2QR0680Z is a current mode controller, it would have a cycle-by-cycle primary current and feedback voltage control which can make sure the maximum power of the converter is controlled in every switching cycle.

6.4 Digital Frequency Reduction

During normal operation, the switching frequency for ICE2QR0680Z is digitally reduced with decreasing load. At light load, the MOSFET will be turned on not at the first minimum drain-source voltage time, but on the n^{th} . The counter is in range of 1 to 7, which depends on feedback voltage in a time-base. The feedback voltage decreases when the output power requirement decreases, and vice versa. Therefore, the counter is set by monitoring voltage V_{FB} . The counter will be increased with low V_{FB} and decreased with high V_{FB} . The thresholds are preset inside the IC.

6.5 Burst Mode Operation

At light load condition, the SMPS enters into Active Burst Mode. At this stage, the controller is always active but the Vcc must be kept above the switch off threshold. During active burst mode, the efficiency increase significantly and at the same time it supports low ripple on V_{out} and fast response on load jump.

For determination of entering Active Burst Mode operation, three conditions apply:

1. the feedback voltage is lower than the threshold of $V_{\text{FBEB}}(1.25\text{V})$. Accordingly, the peak current sense voltage across the shunt resistor is 0.18V;
2. the up/down counter is 7;
3. and a certain blanking time, 24ms (t_{BEB}).

Once all of these conditions are fulfilled, the Active Burst Mode flip-flop is set and the controller enters Active Burst Mode operation. This multi-condition determination for entering Active Burst Mode operation prevents mis-triggering of entering Active Burst Mode operation, so that the controller enters Active Burst Mode operation only when the output power is really low during the preset blanking time.

During active burst mode, the maximum current sense voltage is reduced from 1V to 0.34V so as to reduce the conduction loss and the audible noise. At the burst mode, the FB voltage is changing like a saw-tooth between 3.0 and 3.6V. The switching frequency is set to a fix frequency of 52 kHz.

The feedback voltage immediately increases if there is a high load jump. This is observed by one comparator. As the current limit is 34% during Active Burst Mode a certain load is needed so that feedback voltage can exceed VLB (4.5V). After leaving active burst mode, maximum current can now be provided to stabilize V_{O} . In addition, the up/down counter will be set to 1 immediately after leaving Active Burst Mode. This is helpful to decrease the output voltage undershoot

7 Protection Features

7.1 Vcc under voltage and over voltage protection

During normal operation, the VCC voltage is continuously monitored. When the Vcc voltage falls below the under voltage lock out level (V_{VCCoff}) or the Vcc voltage increases up to V_{VCCOVp} , the IC will enter into Auto Restart Mode.

7.2 Foldback point protection

For a quasi-resonant flyback converter, the maximum possible output power is increased when a constant current limit value is used for all the mains input voltage range. This is usually not desired as this will increase additional cost on transformer and output diode in case of output over power conditions.

The internal fold back protection is implemented to adjust the V_{cs} voltage limit according to the bus voltage. Here, the input line voltage is sensed using the current flowing out of ZC pin, during the MOSFET on-time. As the result, the maximum current limit will be lower at high input voltage and the maximum output power can be well limited versus the input voltage.

7.3 Open loop/over load protection

In case of open control loop, feedback voltage is pulled up with internally block. After a fixed blanking time 30ms, the IC enters into auto restart mode. In case of secondary short-circuit or overload, regulation voltage V_{FB} will also be pulled up, same protection is applied and IC will auto restart.

7.4 Adjustable output overvoltage protection

During off-time of the power switch, the voltage at the zero-crossing pin ZC is monitored for output overvoltage detection. If the voltage is higher than the preset threshold 3.7V for a preset period 100 μ s, the IC is latched off.

7.5 Short winding protection

The source current of the MOSFET is sensed via two shunt resistors R4 and R4A in parallel. If the voltage at the current sensing pin is higher than the preset threshold V_{CSSW} of 1.68V during the on-time of the power switch, the IC is latched off. This constitutes a short winding protection. To avoid an accidental latch off, a spike blanking time of 190ns is integrated in the output of internal comparator.

7.6 Auto restart for over temperature protection

The IC has a built-in over temperature protection function. When the controller's temperature reaches 140 °C, the IC will shut down switch and enters into Auto Restart Mode. This can protect power MOSFET from overheated.

8 Circuit diagram

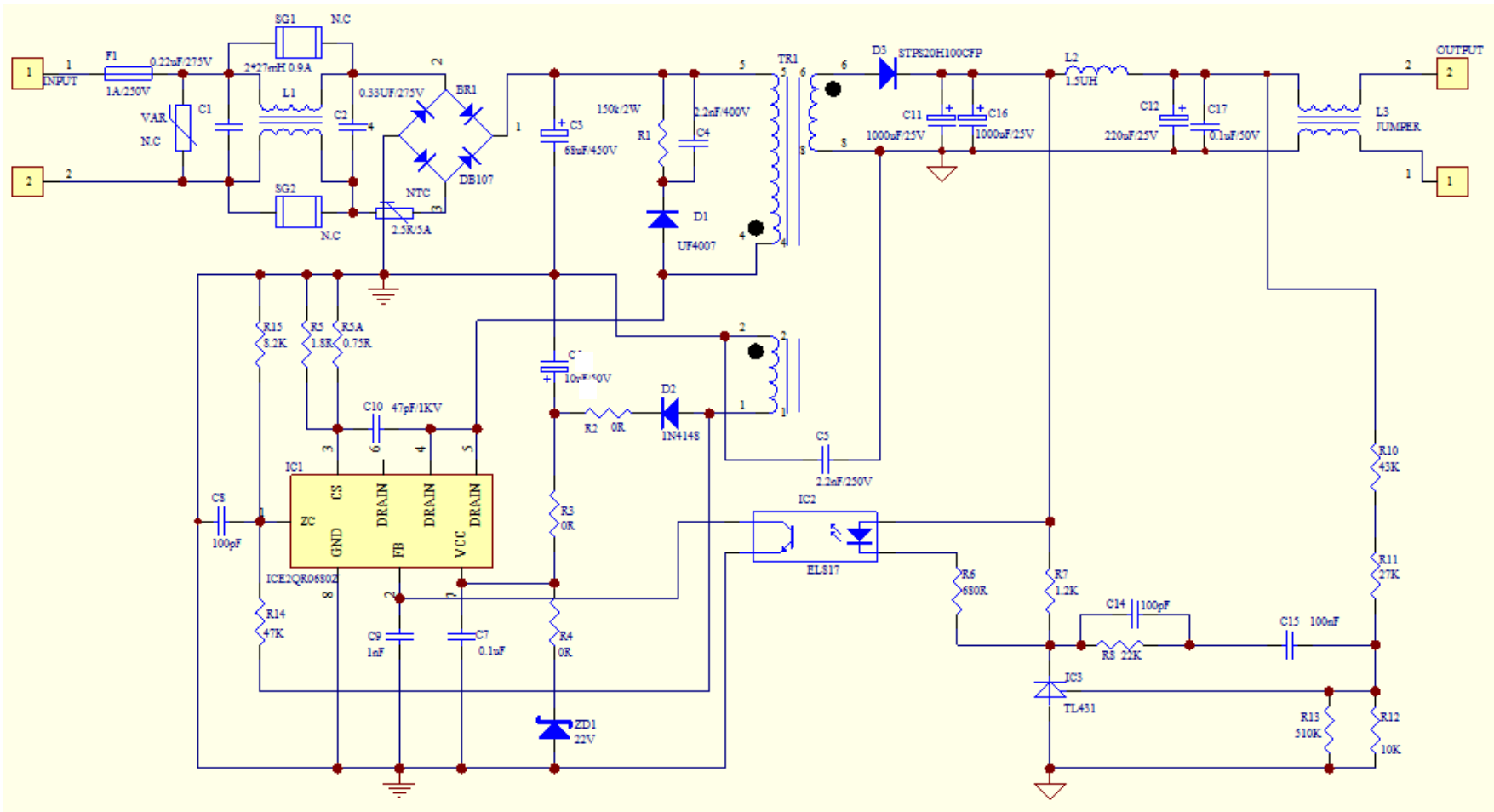

40W 20V SMPS Demoboard with ICE2QR0680Z

Figure 2 Schematics

8.1 PCB Top side

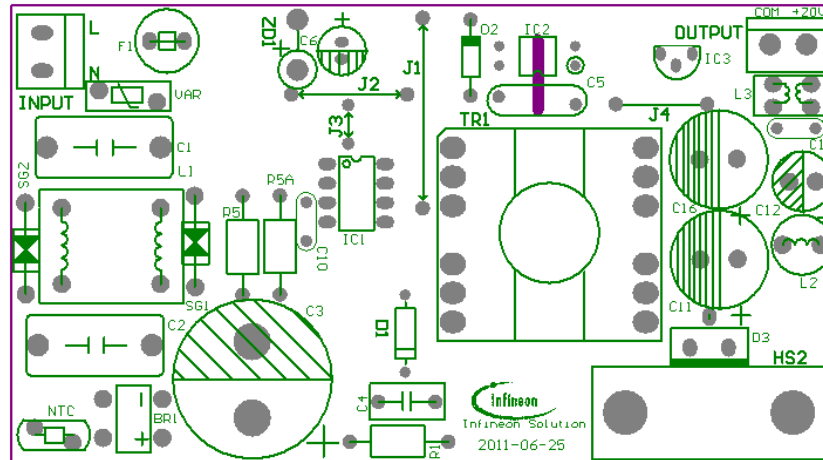

Figure 3 Component Legend – View from top side

8.2 PCB Bottom Layer

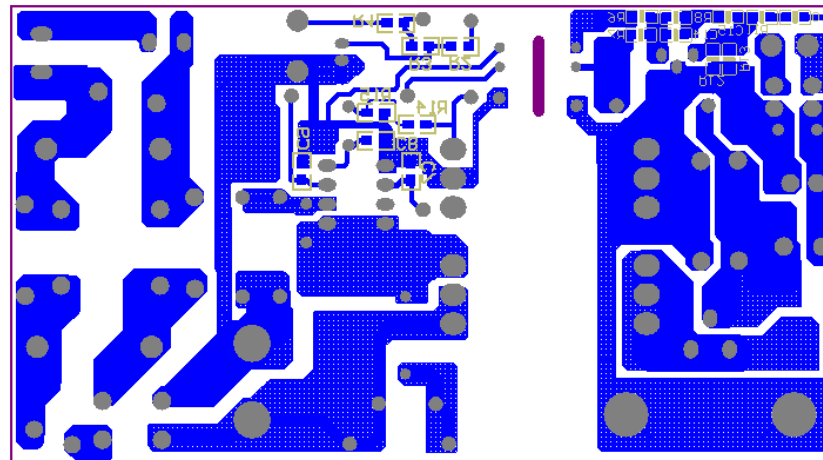

Figure 4 Solder side copper – View from top side

9 Component List

Table 1 Component List

Items	Circuit code	Part type	Part No.	Manufacturer
1	BR1	DB107, 1000V		
2	C1	220nF/275Vac, X-cap	224K/275VAC15MM	
3	C10	47pF/1kV		
4	C11	1000uF/25V		
5	C12	220uF/25V		
6	C14	100pF		
7	C15	100nF		
8	C16	1000uF/25V		
9	C17	0.1uF/50V		
10	C3	68uF/450V		
11	C4	2.2nF/400V		
12	C5	2.2nF/250V, Y-cap		
13	C7	0.1uF		
14	C8	100pF		
15	C9	1nF		
16	D1	UF4007		
17	D2	1nN4148		
18	D3	STPS20H100CFP, schottky		
19	F1	1.0A/250Vac, fuse		
20	IC1	ICE2QR0680Z, QR CoolSET	ICE2QR0680Z	IFX
21	IC2	EL817, opto-coupler		
22	IC3	TL431		
23	L1	2 x 27mH, 0.9A, CMC	B82732R2901B30	Epcos
24	L2	1.5uH		
25	R1	150k/2W		
26	R10	43k		
27	R11	27k		
28	R12	10k		
29	R13	510k		
30	R14	47k		
31	R15	8.2K		
32	R2	0R		
33	R3	0R		
34	R4	0R		
35	R5	1.8R		
36	R5A	0.75R		
37	R6	680R		
38	R7	1.2k		
39	R8	22k		
40	TR1	Lp = 750uH, PQ2620 core		
41	ZD1	22V zener		

10 Transformer Construction

Core and material : PQ2620, PC40

Bobbin: Vertical Version

Primary Inductance, $L_p=750\mu H \pm 10\%$, measured between pin 4 and pin 5 (Gapped to Inductance)

Air Gap in center leg

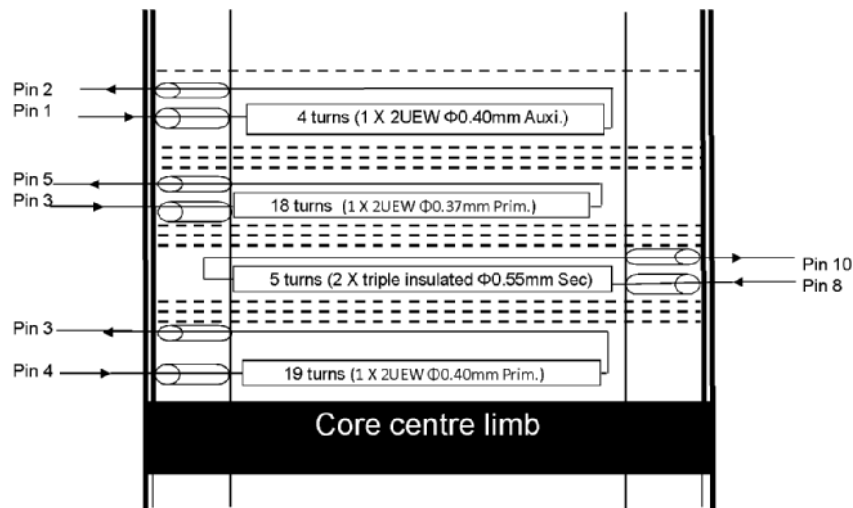

Figure 5 Transformer structure

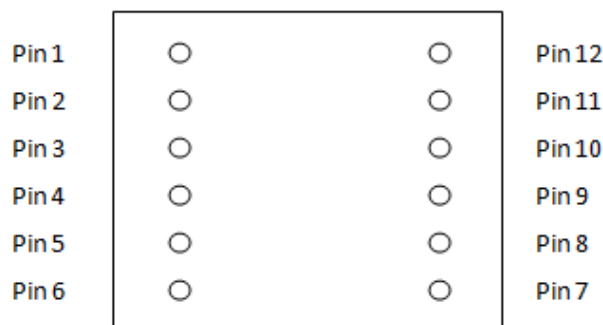

Figure 6 Transformer complete – top view

Table 2 wire gauge used of the transformer windings

Start	Stop	No. of turns	Wire Size	Layer
4	3	19	2UEW, ϕ 0.40mm *1p	½ primary
8	10	5	Triple insulated ϕ 0.55mm *2p	Secondary
3	5	18	2UEW, ϕ 0.37mm *1p	½ primary
1	2	4	2UEW, ϕ 0.40mm *1p	Auxiliary

11 Test Results

11.1 Efficiency and standby performance

Table 3 Efficiency vs. Load

Voltage (Vac)	Input Power (W)	Output Voltage (V)	Output Current (A)	Output Power (W)	Efficiency (%)
85	11.68	20.26	0.5062	10.255612	87.80
85	23.46	20.26	1.0143	20.549718	87.59
85	35.15	20.27	1.5075	30.557025	86.93
85	47.67	20.27	2.0025	40.590675	85.15
115	11.56	20.26	0.5062	10.255612	88.72
115	23.45	20.26	1.0143	20.549718	87.63
115	34.37	20.27	1.5075	30.557025	88.91
115	45.93	20.27	2.0025	40.590675	88.38
150	11.533	20.26	0.5062	10.255612	88.92
150	22.9	20.26	1.0143	20.549718	89.74
150	34.01	20.27	1.5075	30.557025	89.85
150	45.15	20.27	2.0025	40.590675	89.90
180	11.567	20.26	0.5062	10.255612	88.66
180	22.83	20.26	1.0143	20.549718	90.01
180	33.79	20.27	1.5075	30.557025	90.43
180	45.05	20.27	2.0025	40.590675	90.10
230	11.67	20.26	0.5062	10.255612	87.88
230	22.85	20.26	1.0143	20.549718	89.93
230	33.8	20.27	1.5075	30.557025	90.41
230	44.87	20.27	2.0025	40.590675	90.46
282	11.82	20.26	0.5062	10.255612	86.76
282	22.92	20.26	1.0143	20.549718	89.66
282	33.89	20.27	1.5075	30.557025	90.17
282	44.85	20.27	2.0025	40.590675	90.50

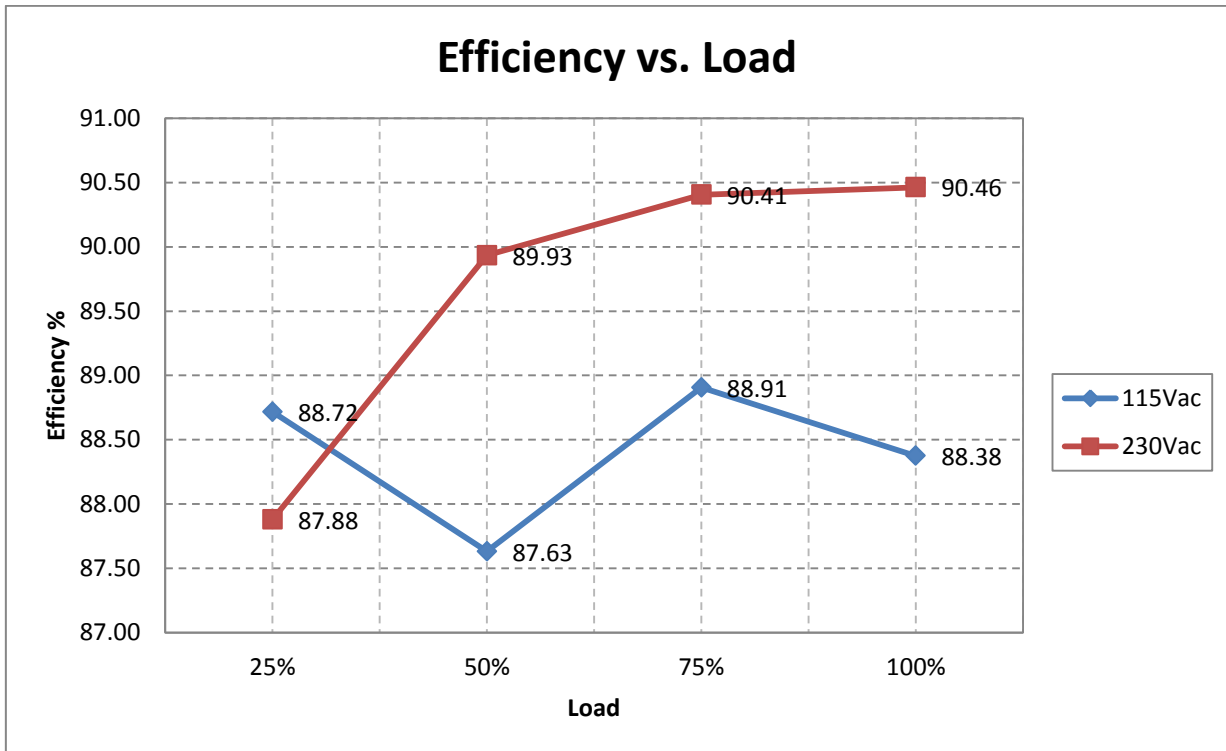
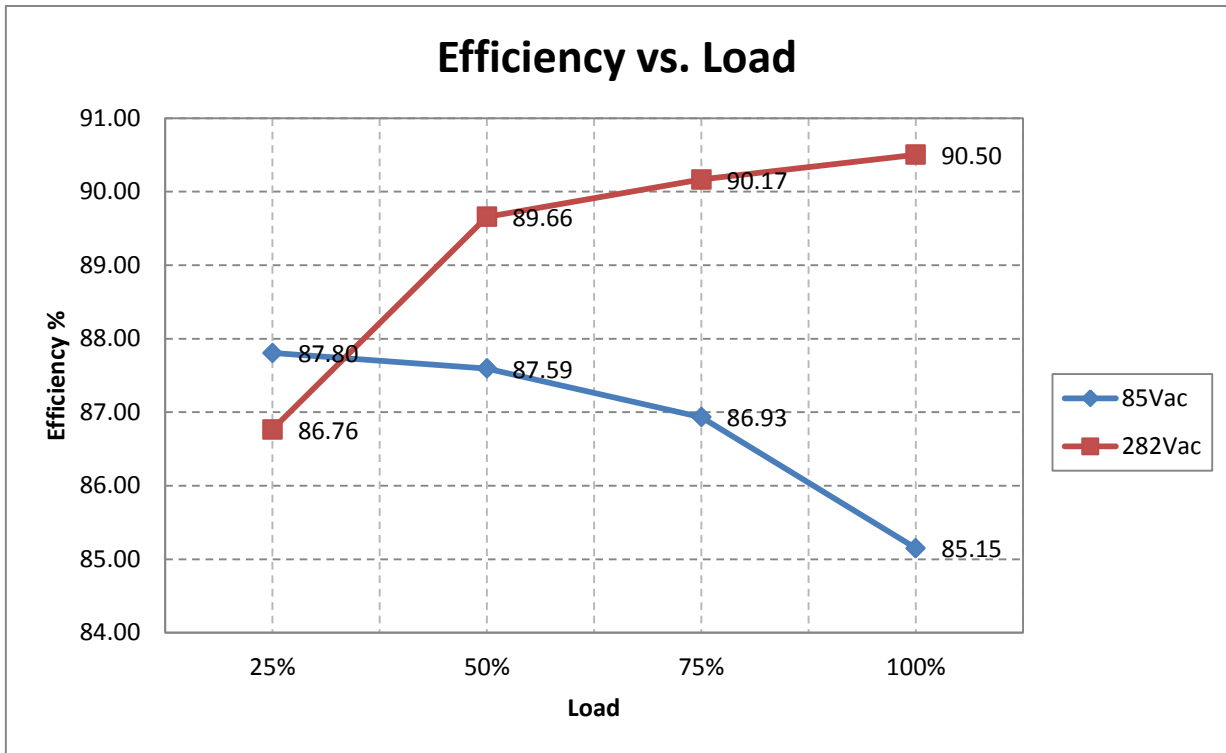

Figure 7 Efficiency vs. Output Load

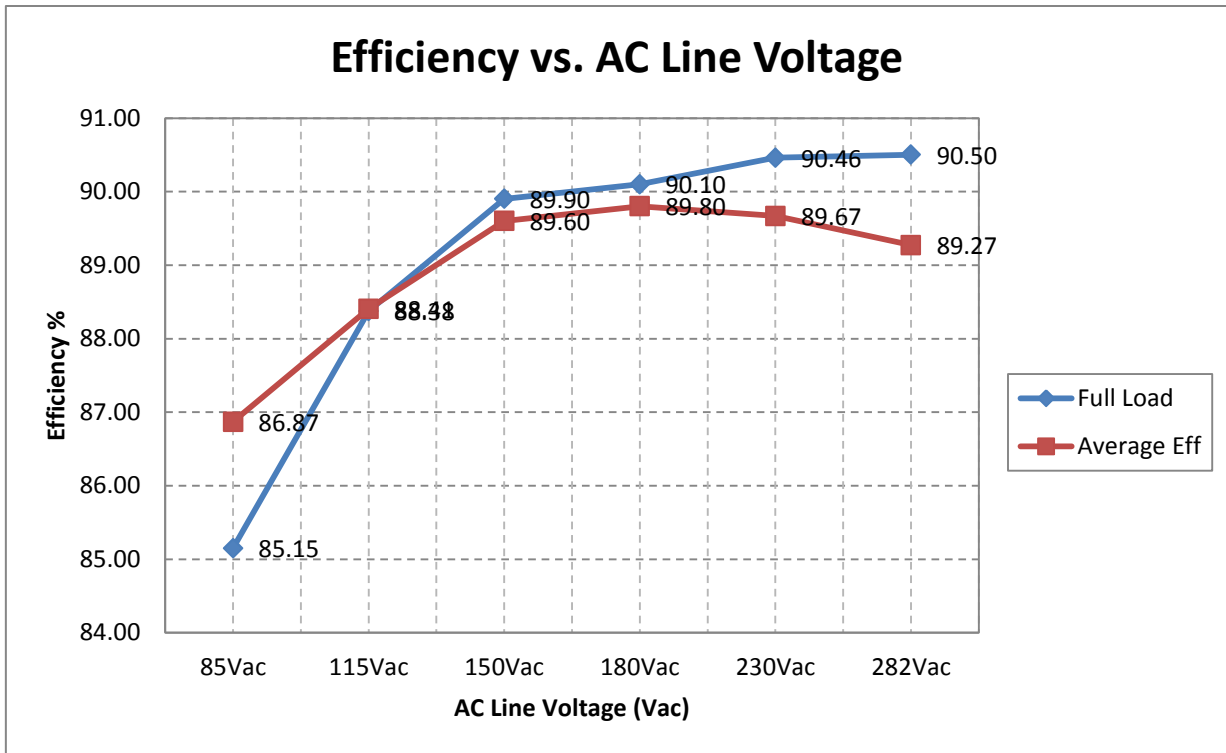

Figure 8 Efficiency vs AC line voltage

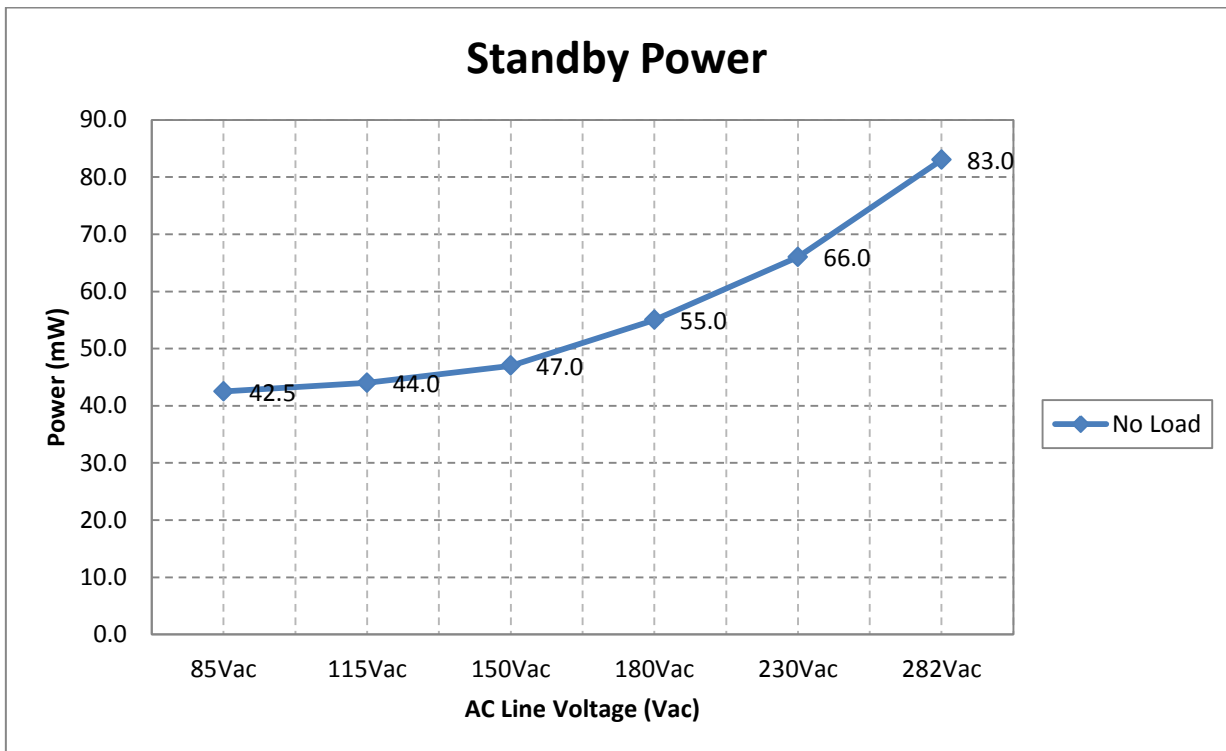

Figure 9 Standby input power vs AC line voltage

12 References

- [1] ICE2QR0680Z data sheet, Infineon Technologies AG, 2011
- [2] ICE2QRxx65/80x Quasi Resonance CoolSET Design Guide V1.1 8 August 2011 AN-PS0053, Infineon Technologies AG, 2011